

# Big-Lock Tubing

Total Solutions for Air, Vacuum  
and Inert Gas Systems

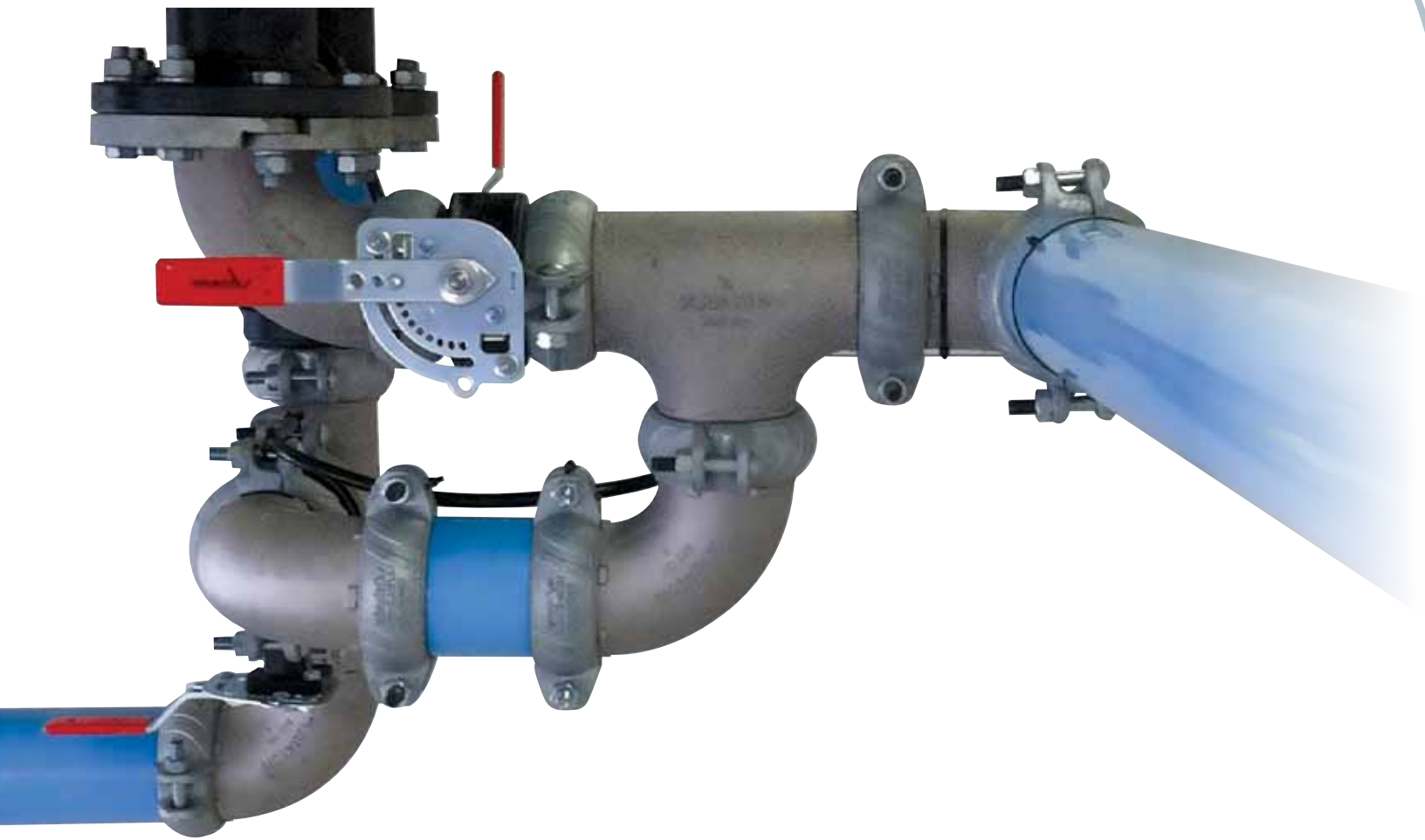

**GD**  
**GARDNER DENVER™**

*Experience Proven Results™*

# High Quality Aluminum Piping Systems

Simply stated there is no equal. Big-Lock from Gardner Denver has taken large diameter piping systems to a new level.

Ten times lighter than steel, without compromising any structural strength, the system is easier to install than plastic and delivers a quality of air, gas or vacuum that is equal to that of high cost welded stainless steel systems.

The secret of the Big-Lock system is twofold. First is the tubing design. Big-Lock is manufactured from marine grade aluminium that affords it the highest level of protection against contamination. This ensures that the media travelling through a system encounters very little turbulence, while enabling high flow rates with minimal pressure losses compared to conventional steel systems.

Secondly, Big-Lock incorporates the world's most highly accepted grooved fitting design. All mechanical contractors will understand the technology and will be able to install an Big-Lock system. We ensure that all fittings coming into contact with the media flowing through a system are manufactured from high quality aluminum so that system integrity will never be compromised. Zero contamination is a priority; it is the only solution to achieve the lowest cost of ownership when operating a piping system.

Big-Lock provides a simple solution for large air/gas/vacuum users and is, without a doubt, the easiest and fastest system to install. It has the lowest cost of ownership and the best quality of media delivery available.

Outstanding performance from an outstanding product is what we demand and what you should expect from our system.



*Simply stated:  
There is no equal.*



## Big-Lock Complete:

### NOW SWITCH TO QUICK-LOCK TO PROVIDE THE TOTAL SOLUTION

Once you have installed a Big-Lock header, it is common to have smaller diameter piping for drops and solid line hook ups to machines and equipment.

Quick-Lock, like Big-Lock, promotes a total metal solution with bore sizes from 20 mm ( $\frac{3}{4}$ "") up to 63 mm ( $2\frac{1}{2}$ "").

The piping is manufactured in the same marine grade aluminum as Big-Lock but promotes a different range and style of fittings.

Quick-Lock fittings are made from solid brass and nickel-plated to provide a strong and non-corrosive solution. The fitting design is a simple "push to connect" system and requires minimal skill, effort or tooling to install.

### It could not be easier

Simply drill a hole in the Big-Lock piping and fix an outlet saddle clamp around the tubing to leave a female threaded connection that allows for the simple conversion between Big-Lock and Quick-Lock.



*Attach saddle clamp to Big-Lock pipe with female threaded connection*



*Screw male thread connector into female connector*



*Attach Quick-Lock piping to fitting*

# High Quality Aluminum Piping Systems

- Lightest product in the market
- Fastest installed system compared to all others available
- Structurally as strong as carbon steel
- One-tenth the weight of same diameter steel
- Tube and fittings manufactured from non-corrosive marine grade aluminum
- Guaranteed highest quality air delivery
- Material construction and design allows highest flow rates and lowest pressure drops
- System flexibility means simple modifications and/or additions
- Ten year leak free guarantee
- “Green” – Big-Lock is manufactured from 100% recyclable materials

SMOOTH BORE  
HIGH-PERFORMANCE

HOUSING

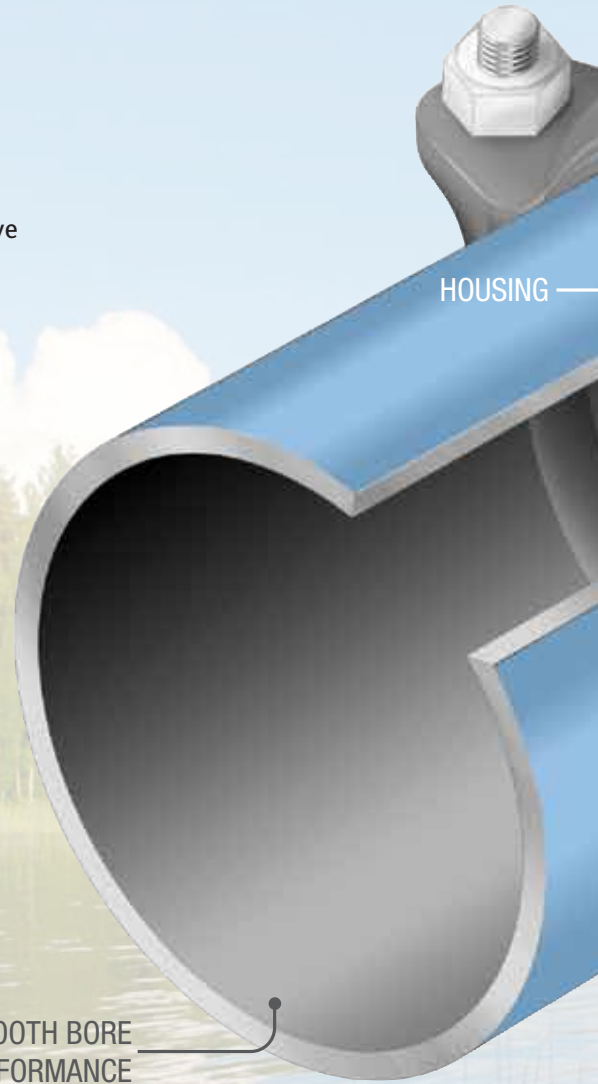

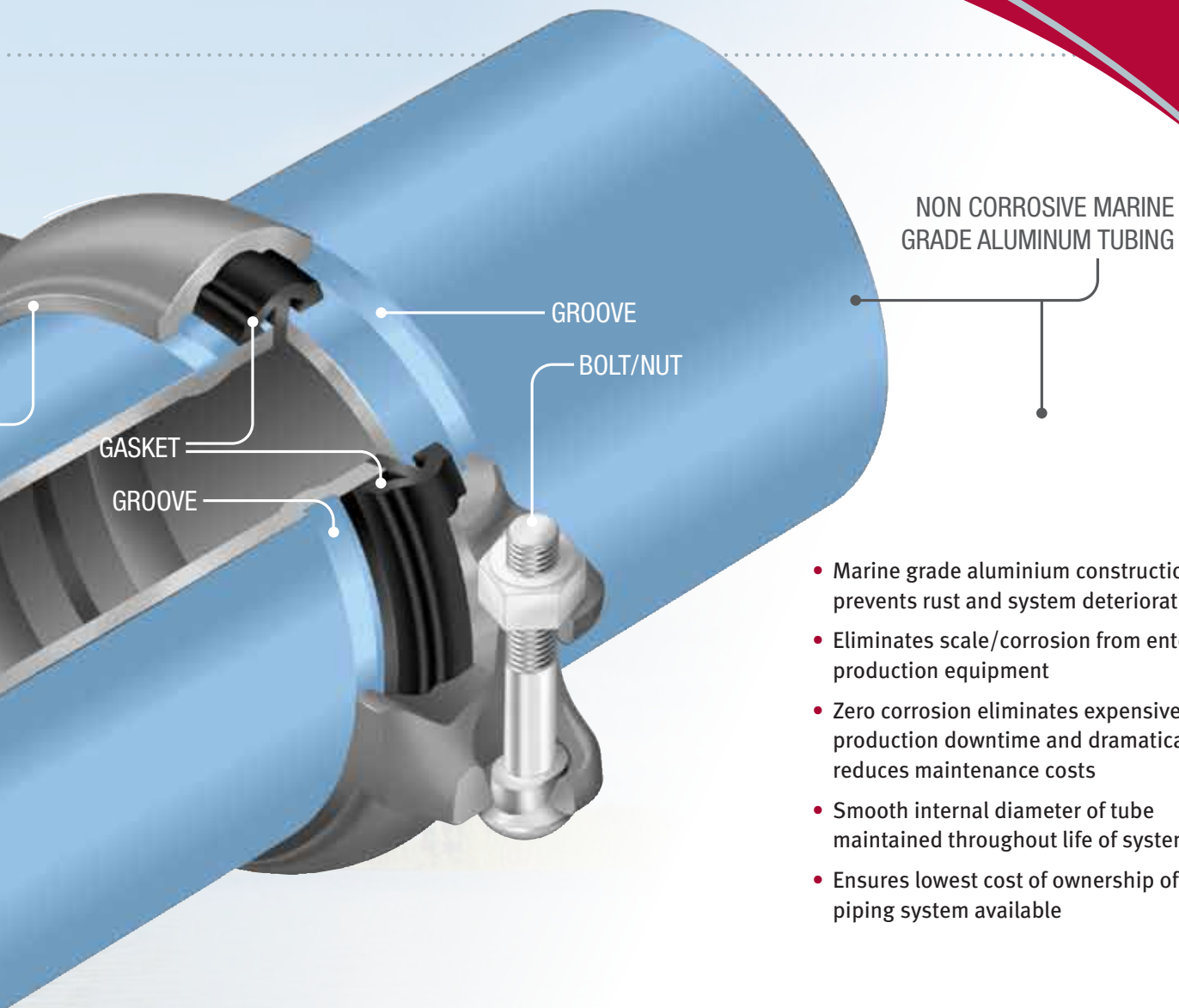

- Marine grade aluminium construction prevents rust and system deterioration
- Eliminates scale/corrosion from entering production equipment
- Zero corrosion eliminates expensive production downtime and dramatically reduces maintenance costs
- Smooth internal diameter of tube maintained throughout life of system
- Ensures lowest cost of ownership of any piping system available



## Don't jeopardize air handling efficiency

Compressed air piping is responsible for the delivery of compressed air to the point of use. Its material, age and condition impact both system reliability and air quality. Compressed air piping made from iron will rust and corrode, creating buildup on the interior and reducing the functional diameter. This buildup results in pressure drop within the system, contributing to high levels of contamination and poor air quality.

# Components

Compressed Air Piping - Blue  
 Vacuum Piping - Grey  
 Inert Gases Piping - Black

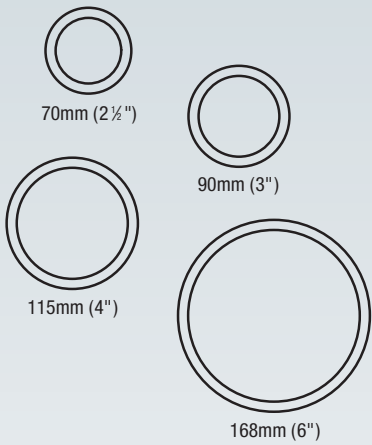

Adapters

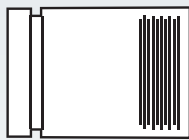

Adapter, Male

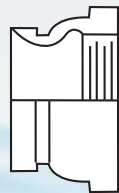

Adapter, Female

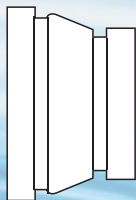

Reducer

ANSI Flanges & Flange Adapter Kits

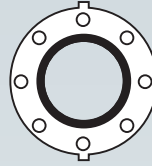

Straight Union Couplings

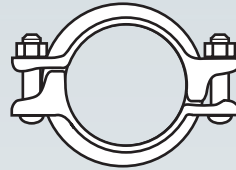

90° Union Elbows with Couplings

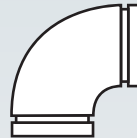

45° Union Elbows with Couplings



Equal Tee with Couplings

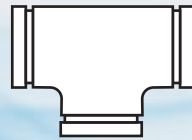

Outlet, Saddle Clamp



Plug, Cap End Fitting



Butterfly Valve  
 Tube to Tube with Couplings

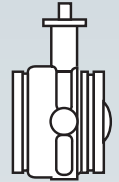

Hanging Brackets



Hanging Wire System

Wall Bracket Kit

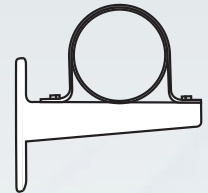

Replacement Seals

Tools

Manual Grooving Tool

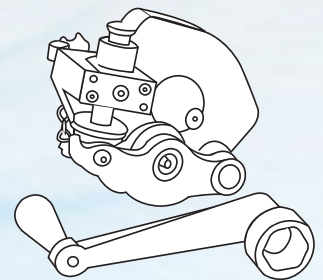

# Specifications

## BIG-LOCK TECHNICAL SPECIFICATIONS

Max Working Pressure	220 PSI (15 BAR)
Max Working Temperature	-4° F to 176° F (100% Duty)
Tubing Material	Aluminum, ASTM 6061-T4 (Marine Grade)
Tubing Weight	70 mm – 0.86 lbs./ft
	90 mm – 1.04 lbs./ft
	115 mm – 1.15 lbs./ft
	168 mm – 3.12 lbs./ft
	220 mm – 4.95 lbs./ft
Standard Seals	(-4° F to 176° F) Nitrile Rubber
High Temperature Seals	(-4° F to 300° F) Fluoroelastomer
Fittings	Aluminum, B-26, 356-T6
Couplings	Ductile Iron, Galvanized, Grade 65-45-12
Standards & Approvals	ASME B31.1 Power Piping ASTM F-1476 BOCA CSA B-242 SBCCI



## BIG-LOCK SYSTEM FLOW RATES

	Cu Ft/min				
	70 mm	90 mm	115 mm	168 mm	220 mm
100 PSI	948	1955	3844	10078	20944
125 PSI	1064	2162	4205	11194	23169
150 PSI	1169	2364	4591	12153	25279
220 PSI	1417	2937	5568	14740	30418

Above flow rates are based on straight line flow allowing for a 1 psi pressure drop per 100 ft over pipe and couplings. For loop systems, flow rates are doubled, i.e. 90 mm tubing at 100 psi flows 3910 cfm

## 10 Year Guarantee

Gardner Denver warrants its pipe and fitting components to be free of leaks due to manufacturing defects for a period of 10 years from date of sale. This Express warranty is in lieu of and excludes all other warranties, guarantees or representations, express or implied, by operation of law or otherwise, including any warranty that the materials are suitable for the buyer's requirements or special use. System must be installed by an Gardner Denver approved

technician.

Gardner Denver agrees to replace any component proven to have a manufacturing defect.

Gardner Denver shall not be liable for any consequential damages nor for loss, damage or expenses directly or indirectly arising from the use of the product.



## Whatever Your Request – Gardner Denver Has the Smart Solution!

The **Gardner Denver rotary screw compressor** range from 5–500 horsepower, is designed to meet today's modern work environment and machine operators' highest requirements. As a result, Gardner Denver compressors are extremely energy efficient, quiet and reliable.

**Oil-free Gardner Denver EnviroAire** rotary screw compressors (15–110 kW) provide high quality and energy-efficient compressed air for use in a wide range of applications. The totally oil-free design eliminates the issue of contaminated air, reducing the risk and associated cost of product spoilage and rework, particularly for those customers operating in sterile environments.

Modern production systems and processes demand increasing levels of air quality. Our complete **air treatment range** ensures the highest product quality and efficient operation.

### Our product range includes:

- Refrigerant Dryers
- Desiccant Dryers
- Membrane Dryers
- Condensate Management
- Oil/Water Separators
- Air Filters

Compressor systems are typically comprised of multiple compressors delivering air to a common header. The combined capacity of these machines is generally greater than the maximum site demand. To ensure the system is operated to the highest levels of efficiency, the use of a **GD Connect air management system** is essential.

- The modern **GD Connect 12** air management system can intelligently control up to twelve fixed speed or variable speed compressors.
- The simple **GD Connect 4** air system is the ideal control solution for smaller compressed air stations, and will intelligently control up to four fixed speed compressors.

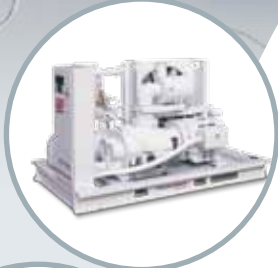

# **Gardner Denver**®

[www.GardnerDenverProducts.com](http://www.GardnerDenverProducts.com)

Gardner Denver, Inc. 1800 Gardner Expressway, Quincy, IL 62305

[www.contactgd.com/compressors](http://www.contactgd.com/compressors)

866-440-6241

©2014 Gardner Denver, Inc. Printed in U.S.A. GA-BLT-100 2nd 6/14



 Please recycle after use.